



*we*innovate cooking

KITCHENS DIAMANTE 90

GRIDDLE PLATES

Model

D92/10FTE

Code

CR0996329

General characteristics

- Stainless steel outer coatings and feet.
- Worktops made of 2 mm thick, brushed AISI 304 stainless steel.
- Adjustable worktop height from 840 to 900 mm.
- Contoured control panels with controls tilted towards the operator.
- Large knobs that do not protrude from the machine structure.
- Range modularity: 200-400-600-800-1200.
- Simple and effective coupling system.
- Appliances set up for the plinth.
- Vast accessory range.
- Appliances in compliance with CE standards.

ELECTRIC GRIDDLE WITH SMOOTH PLATE ON OPEN CUPBOARD



Technical/functional characteristics

- Outer casing and feet in stainless steel. Adjustable worktop height, ranging from 840 to 900 mm. Recessed hot plate, 40 mm lower than worktop surface. Enamelled hot plate surface, with hard polished chrome plating, available in smooth, ribbed or mixed finish versions. Plate slants 10mm forwards. Large grease drawer.
- Electric model: incoloy armoured heaters.
- Thermostatically-controlled temperature range from 110 to 280°C.
- Safety thermostat.

Technical Data

Model	D92/10FTE
Width (mm)	400,00
Depth (mm)	900,00
Height (mm)	870,00
VOLUME	0,70
WEIGHT	95,00
SUPPLY	EL
Gas power	
Electric power	7.5
Internal ovens dimension	
OVEN CAPACITY	
Plate dimensions (mm)	345x700
TANK DIMENSIONS	
Tank capacity (l)	

GRIDDLE PLATES

Model
D92/10FTE

Code
CR0996329

D92/10 FTE

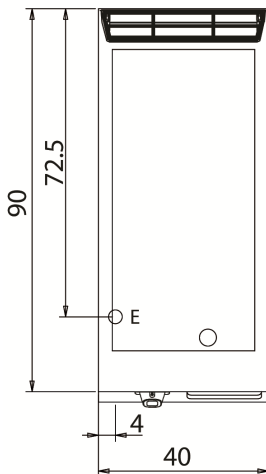
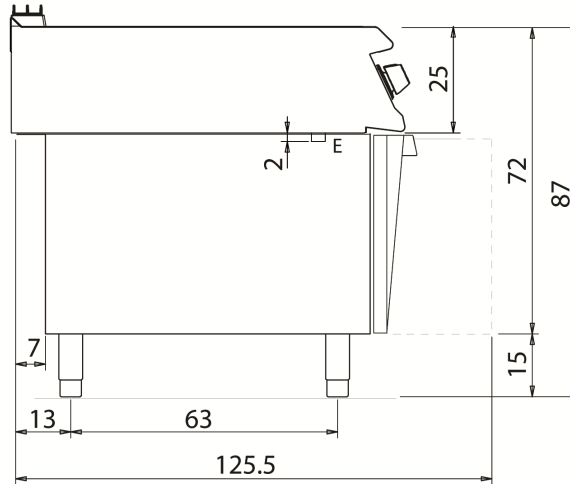
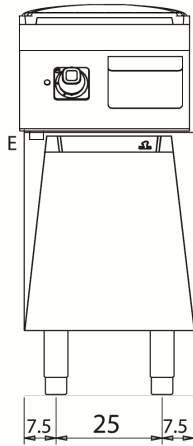

KEY

- E power supply
- G gas connection
- H2O water inlet
- S water outlet

Connection	Power	Diameter	Supply
Gas connecton			
Electric connecton	7.5	400	
Cold water connecton			0
Hot water connecton			
Cold soft water connecton			
Drain (∅)			
2° Drain (∅)			