



*we*innovate cooking

KITCHENS DIAMANTE 90

PASTA-COOKER

Model

D92/10CPG

Code

CR0990989

General characteristics

- Stainless steel outer coatings and feet.
- Worktops made of 2 mm thick, brushed AISI 304 stainless steel.
- Adjustable worktop height from 840 to 900 mm.
- Contoured control panels with controls tilted towards the operator.
- Large knobs that do not protrude from the machine structure.
- Range modularity: 200-400-600-800-1200.
- Simple and effective coupling system.
- Appliances set up for the plinth.
- Vast accessory range.
- Appliances in compliance with CE standards.

1-BASIN GAS PASTA-COOKER 40LTS.



Technical/functional characteristics

- Outer casing and feet in stainless steel.
- Adjustable worktop height, ranging from 840 to 900 mm.
- Moulded AISI 316 stainless steel pan with rounded edges to guarantee maximum corrosion resistance.
- Electrovalve-controlled fast or slow water loading operations.
- Stainless steel water dispenser and water discharge unit at ground level.
- Safety manostat to avoid heating operations when no water in bowl.
- Stainless steel burner mounted on the outside of the bowl for heating operations.
- Gas safety valve with thermocouple, and electric ignition.

Technical Data

Model	D92/10CPG
Width (mm)	400,00
Depth (mm)	900,00
Height (mm)	870,00
VOLUME	0,60
WEIGHT	97,00
SUPPLY	GAS-EL
Gas power	14
Electric power	0.1
Internal ovens dimension	
OVEN CAPACITY	
Plate dimensions (mm)	
TANK DIMENSIONS	310x510x275h
Tank capacity (l)	40Lt.

PASTA-COOKER

Model
D92/10CPG

Code
CR0990989

D92/10 CPG

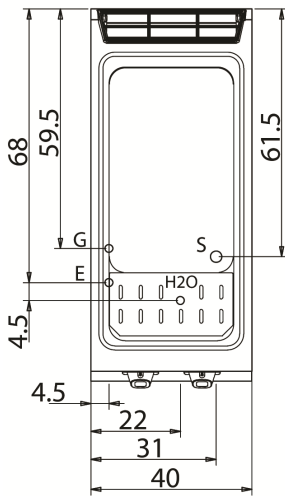
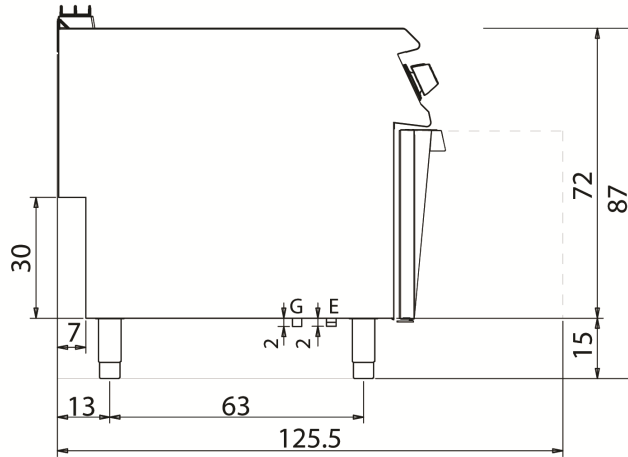
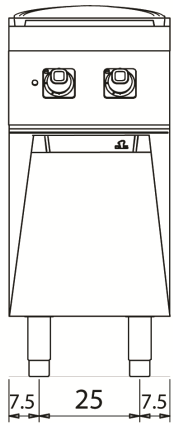

KEY

- E power supply
- G gas connection
- H2O water inlet
- S water outlet

Supply

Gas connecton	14	1/2"	
Electric connecton	0.1	230	
Cold water connecton		3/4"	0
Hot water connecton			
Cold soft water connecton			
Drain (∅)		1"	
2° Drain (∅)			