



*we*innovate cooking

KITCHENS DIAMANTE 70

GRIDDLE PLATES

Model

D72/10TFTE

Code

CR0994389

General characteristics

- Stainless steel outer coatings and feet.
- Worktops made of 1,5 mm thick, brushed AISI 304 stainless steel.
- Adjustable worktop height from 840 to 900 mm.
- Contoured control panels with controls tilted towards the operator.
- Large knobs that do not protrude from the machine structure.
- Range modularity: 200-400-600-800-1200.
- Simple and effective coupling system.
- Appliances set up for the plinth.
- Vast accessory range.
- Appliances in compliance with CE standards.

ELECTRIC GRIDDLE WITH SMOOTH PLATE TOP



Technical/functional characteristics

- Outer casing and feet in stainless steel.
- Adjustable worktop height, ranging from 840 to 900 mm.
- Recessed hot plate, 40 mm lower than worktop surface.
- Enamelled hot plate surface smooth.
- Plate slants 10mm forwards.
- Large grease drawer.
- Incoloy armoured heaters.
- Thermostatically-controlled temperature range from 110 to 280°C.
- Safety thermostat.

Technical Data

Model	D72/10TFTE
Width (mm)	400,00
Depth (mm)	730,00
Height (mm)	250,00
VOLUME	0,16
WEIGHT	44,00
SUPPLY	EL
Gas power	
Electric power	5.4
Internal ovens dimension	
OVEN CAPACITY	
Plate dimensions (mm)	335x530x14.5
TANK DIMENSIONS	
Tank capacity (l)	

GRIDDLE PLATES

Model
D72/10TFTE

Code
CR0994389

D72/10 TFTE

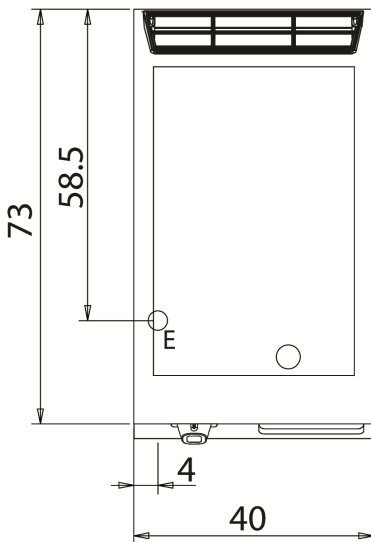
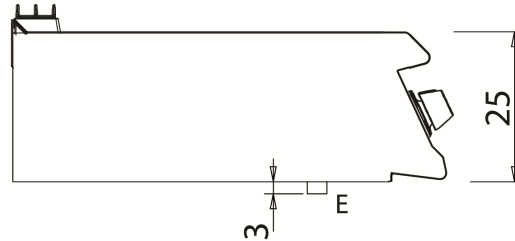
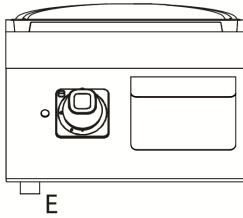

KEY

- E power supply
- G gas connection
- H2O water inlet
- S water outlet

Connection	Power	Diameter	Supply
Gas connecton			
Electric connecton	5.4	400	
Cold water connecton			0
Hot water connecton			
Cold soft water connecton			
Drain (∅)			
2° Drain (∅)			