



*we*innovate cooking

# KITCHENS DIAMANTE 90

## BOILING PANS

Model

D94/10PGI10

Code

CR0991079

### General characteristics

- Stainless steel outer coatings and feet.
- Worktops made of 2 mm thick, brushed AISI 304 stainless steel.
- Adjustable worktop height from 840 to 900 mm.
- Contoured control panels with controls tilted towards the operator.
- Large knobs that do not protrude from the machine structure.
- Range modularity: 200-400-600-800-1200.
- Simple and effective coupling system.
- Appliances set up for the plinth.
- Vast accessory range.
- Appliances in compliance with CE standards.

### GAS BOILING PAN 100 LT. INDIRECT HEATING



### Technical/functional characteristics

Outer casing and feet in stainless steel. Adjustable worktop height, ranging from 840 to 900 mm. Adjustable worktop height, ranging from 840 to 900 mm. AISI 304 stainless steel pan with base in AISI 316 stainless steel. Water loading using the tap and both hot or cold water may be loaded. Front discharge with 2-inch chrome brass taps. Gas model: 2 AISI 304 stainless steel burners positioned on the base of the appliance (for direct heating operations) or in the cavity (for indirect heating operations).

### Technical Data

Model	D94/10PGI10
Width (mm)	800,00
Depth (mm)	900,00
Height (mm)	870,00
VOLUME	1,30
WEIGHT	153,00
SUPPLY	GAS-EL
Gas power	21
Electric power	0.3
Internal ovens dimension	
OVEN CAPACITY	
Plate dimensions (mm)	
TANK DIMENSIONS	Ø=600
Tank capacity (l)	100Lt.

### BOILING PANS

Model  
D94/10PGI10

Code  
CR0991079

**D94/10 PGI10**

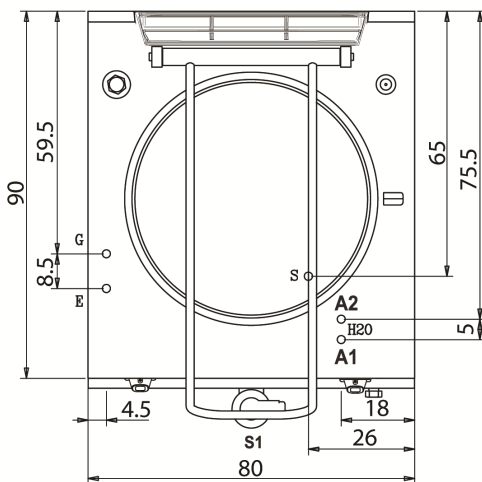
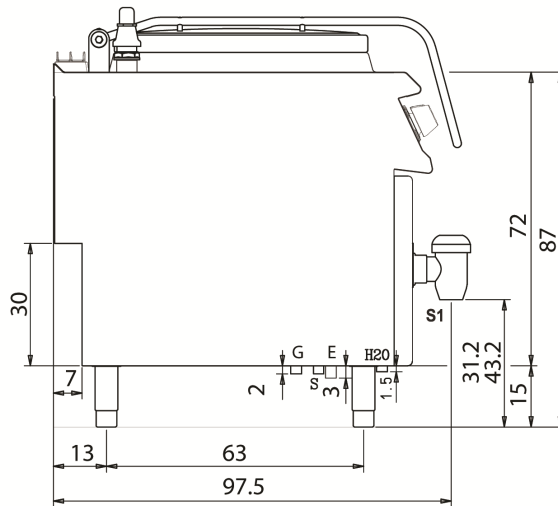
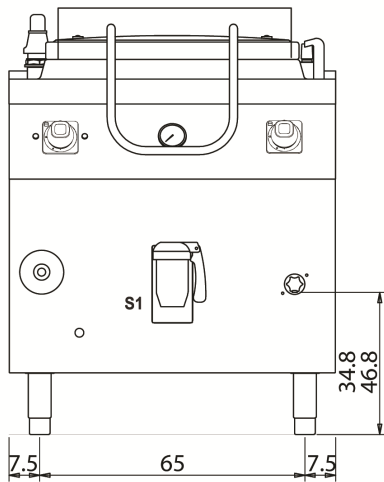

**KEY**

- E power supply
- G gas connection
- H2O water inlet
- S water outlet

**Supply**

Gas connecton	21	1/2"	
Electric connecton	0.3	230	
Cold water connecton		3/4"	0
Hot water connecton		3/4"	
Cold soft water connecton			
Drain (∅)		2"	
2° Drain (∅)			