



*we*innovate cooking

KITCHENS DIAMANTE 70

GRIDDLE PLATES

Model

D73/10FTG

Code

CR0993919

General characteristics

- Stainless steel outer coatings and feet.
- Worktops made of 1,5 mm thick, brushed AISI 304 stainless steel.
- Adjustable worktop height from 840 to 900 mm.
- Contoured control panels with controls tilted towards the operator.
- Large knobs that do not protrude from the machine structure.
- Range modularity: 200-400-600-800-1200.
- Simple and effective coupling system.
- Appliances set up for the plinth.
- Vast accessory range.
- Appliances in compliance with CE standards.

GAS GRIDDLE WITH SMOOTH PLATE ON OPEN CUPBOARD



Technical/functional characteristics

Outer casing and feet in stainless steel. Adjustable worktop height, ranging from 840 to 900 mm. Recessed hot plate, 40 mm lower than worktop surface. Enamelled hot plate surface, with hard polished chrome plating, available in smooth, ribbed or mixed finish versions. Plate slants 10mm forwards. Large grease drawer. Gas model: burner with self-stabilizing flame. Temperature adjustment and regulation with safety tap and thermocouple (200-400°C) or thermostat safety valve with thermocouple (110-280°C).

Technical Data

Model	D73/10FTG
Width (mm)	600,00
Depth (mm)	730,00
Height (mm)	870,00
VOLUME	0,61
WEIGHT	95,00
SUPPLY	GAS
Gas power	9
Electric power	
Internal ovens dimension	
OVEN CAPACITY	
Plate dimensions (mm)	535x530x14.5
TANK DIMENSIONS	
Tank capacity (l)	

GRIDDLE PLATES

Model
D73/10FTG

Code
CR0993919

D73/10 FTG

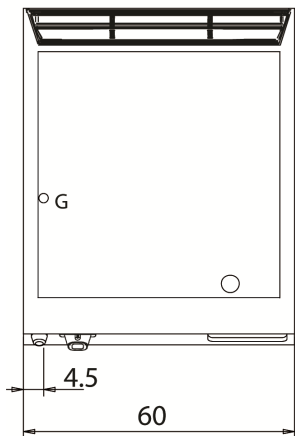
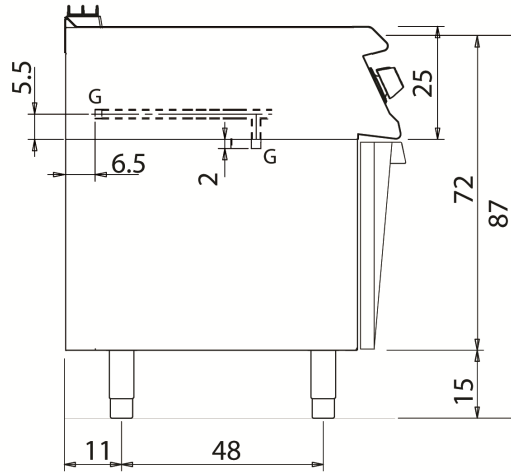
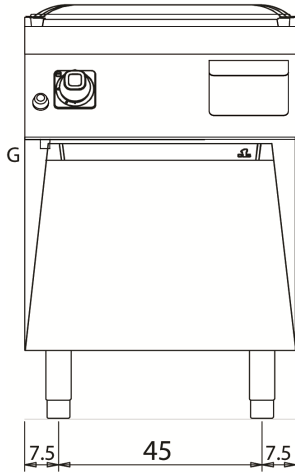

KEY

- E power supply
- G gas connection
- H2O water inlet
- S water outlet

Connection	Power	Diameter	Supply
Gas connecton	9	1/2"	
Electric connecton			
Cold water connecton			
Hot water connecton			
Cold soft water connecton			
Drain (∅)			
2° Drain (∅)			