



EN 10204:2004



HJX-PRO-S80

Josper es una elegante combinación entre una parrilla y un horno en una sola máquina. Trabaja 100% con carbón vegetal, tiene un diseño único de barbacoa cerrada, con diferentes niveles de braseado, un sistema de puerta frontal, ágil y robusta, de fácil manejo y control de temperatura por un sistema de tiros.

Josper is an elegant combination of a grill and an oven in a single machine. It works 100% with charcoal. A unique closed barbecue design. Different levels of grilling. Flexible and robust, easy to use, with a front opening door system. Vent system for temperature control.

Recomendado para ± Recommended for ±	80 comensales 80 dinners
Tiempo de encendido Fire up time	30 min aprox. 30 min average
Consumo diario de carbón Charcoal daily consumption	10 a 12kg 22 to 26.5 lb
Autonomía por carga Performance	9h
Producción por hora Production per hour	60 kg aprox. 132 lb average
Temperatura de braseado Broiling temperature	250 a 350 °C 482 a 662 °F
Capacidad bandejas GN (por parrilla) Grill rack capacity in Gn trays	1xGN1/1
Potencia térmica nominal Nominal heat output	8.8 kW 11.8 hp
Caudal máxico de humos Flue gas mass flow	19.36 g/s 0.68 oz/s
Peso neto Net weight	180 kg 396 lb



ACCESORIOS INCLUIDOS INCLUDED ACCESSORIES

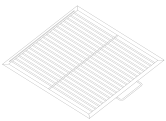

Parrilla inox / Ref. [240024](#)
Inox grill rack / Ref. [240024](#)

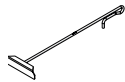

Atizador / Ref. [0401INOX](#)
Poker / Ref. [0401INOX](#)

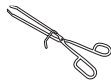

Pinzas Josper / Ref. [0423](#)
Josper tongs / Ref. [0423](#)

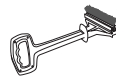

Cepillo metálico / Ref. [8224](#)
Metallic brush / Ref. [8224](#)

MEDIDAS PARRILLA GRILL RACK MEASUREMENTS

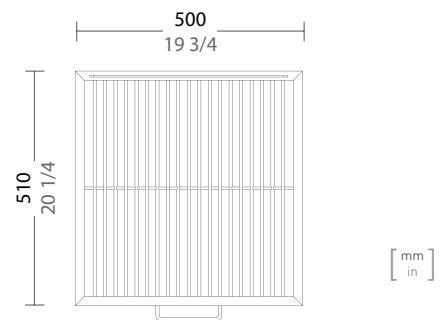

* Todos los productos Josper funcionan exclusivamente con carbón vegetal.
All Josper products work exclusively with charcoal.

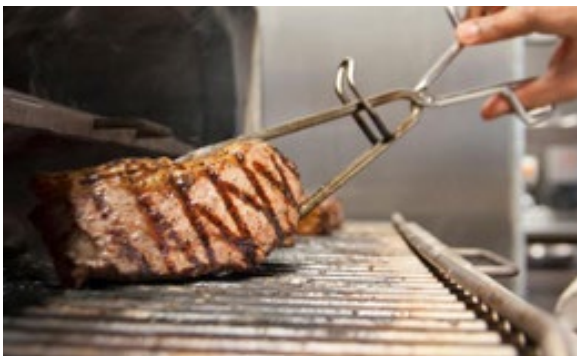

FT-C01925-05

HORNO BRASA JOSPER HJX JOSPER CHARCOAL BROILER OVEN HJX



CONFIGURACIONES Y ACCESORIOS OPCIONALES OPTIONAL CONFIGURATIONS & ACCESSORIES



W - ATEMPERADOR / Ref. 230000
W - WARMER / Ref. 230000



T - MESA / Ref. 200015
T - TABLE / Ref. 200015



TD - MESA CON CAJÓN / Ref. 200016
TD - TABLE WITH DRAWER / Ref. 200016

INSTALACIÓN INSTALLATION

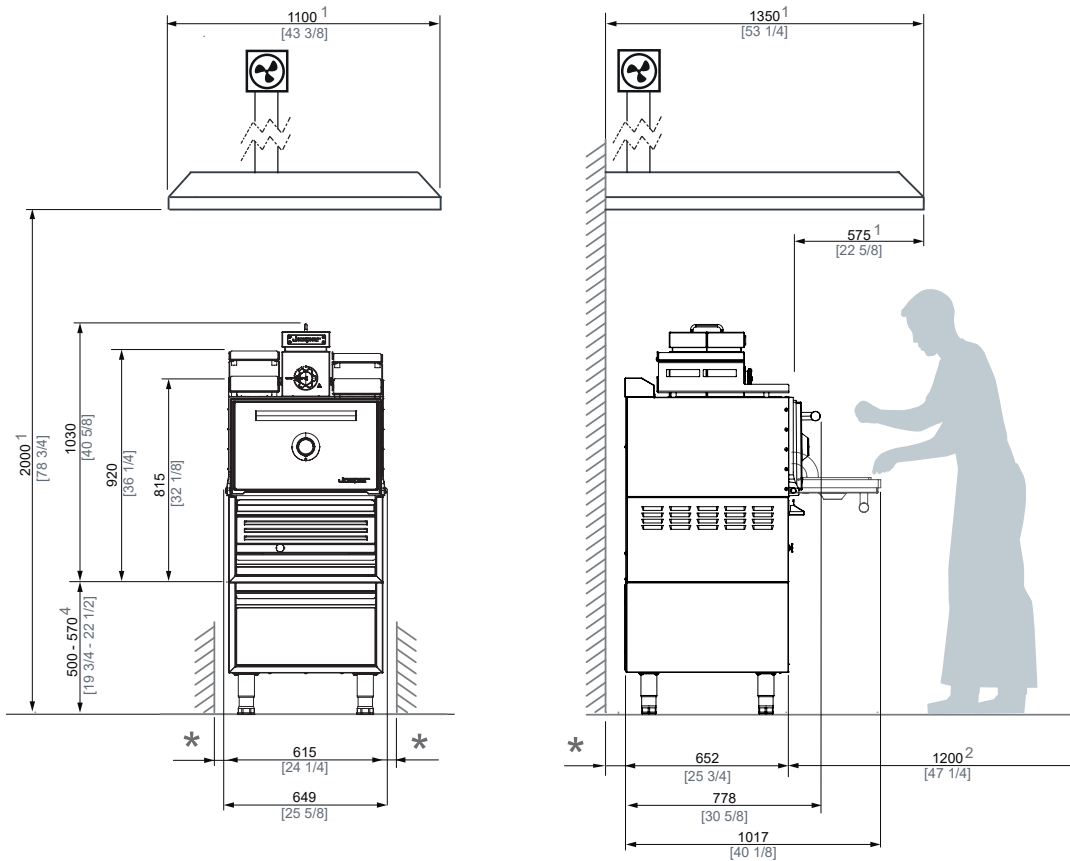

* DISTANCIA MÍNIMA A ELEMENTOS INFLAMABLES MINIMUM DISTANCE TO FLAMMABLE ELEMENTS	300 mm	12 in
* DISTANCIA MÍNIMA A ELEMENTOS NO INFLAMABLES MINIMUM DISTANCE TO FLAMMABLES ELEMENTS	100 mm	4 in

- 1 MEDIDAS MÍNIMAS RECOMENDADAS DE LA CAMPANA EXTRACTORA.
RECOMMENDED HOOD'S MINIMUM DIMENSIONS
- 2 ESPACIO RECOMENDADO DE TRABAJO PARA EL CHEF.
RECOMMENDED CHEF'S WORKING SPACE
- 3 ALTURA RECOMENDADA DE INSTALACIÓN DEL HORNO SIN MESA
RECOMMENDED HEIGHT TO INSTALL THE OVEN WITHOUT TABLE

Ed. 02.2022 - Jospers se reserva el derecho a realizar modificaciones en los catálogos, tarifas y material de divulgación según evolución y mejora de sus equipos.
Jospers reserves the right to make modifications to catalogues, pricelists and promotional material according to the development and improvements applied to its equipment.